

Инструкция по установке

LADA Granta HB

(2019-)



Арт.: F.6013.009

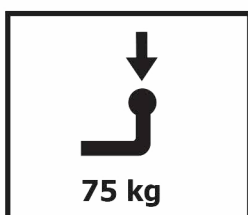
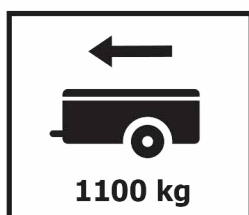

$D = 6,33 \text{ kN}$

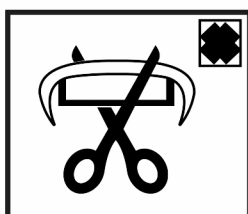

$$D \text{ (kN)} = \frac{\text{MAX kg} \times \text{MAX kg}}{\text{MAX kg} + \text{MAX kg}} \times 0,00981$$

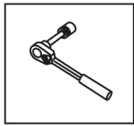

Вкрутить/выкрутить используя инструмент

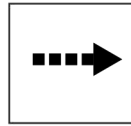

Движение

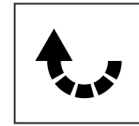

Поворот



Вкрутить/выкрутить не затягивая

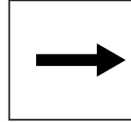





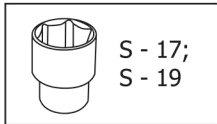
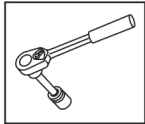

Расположение

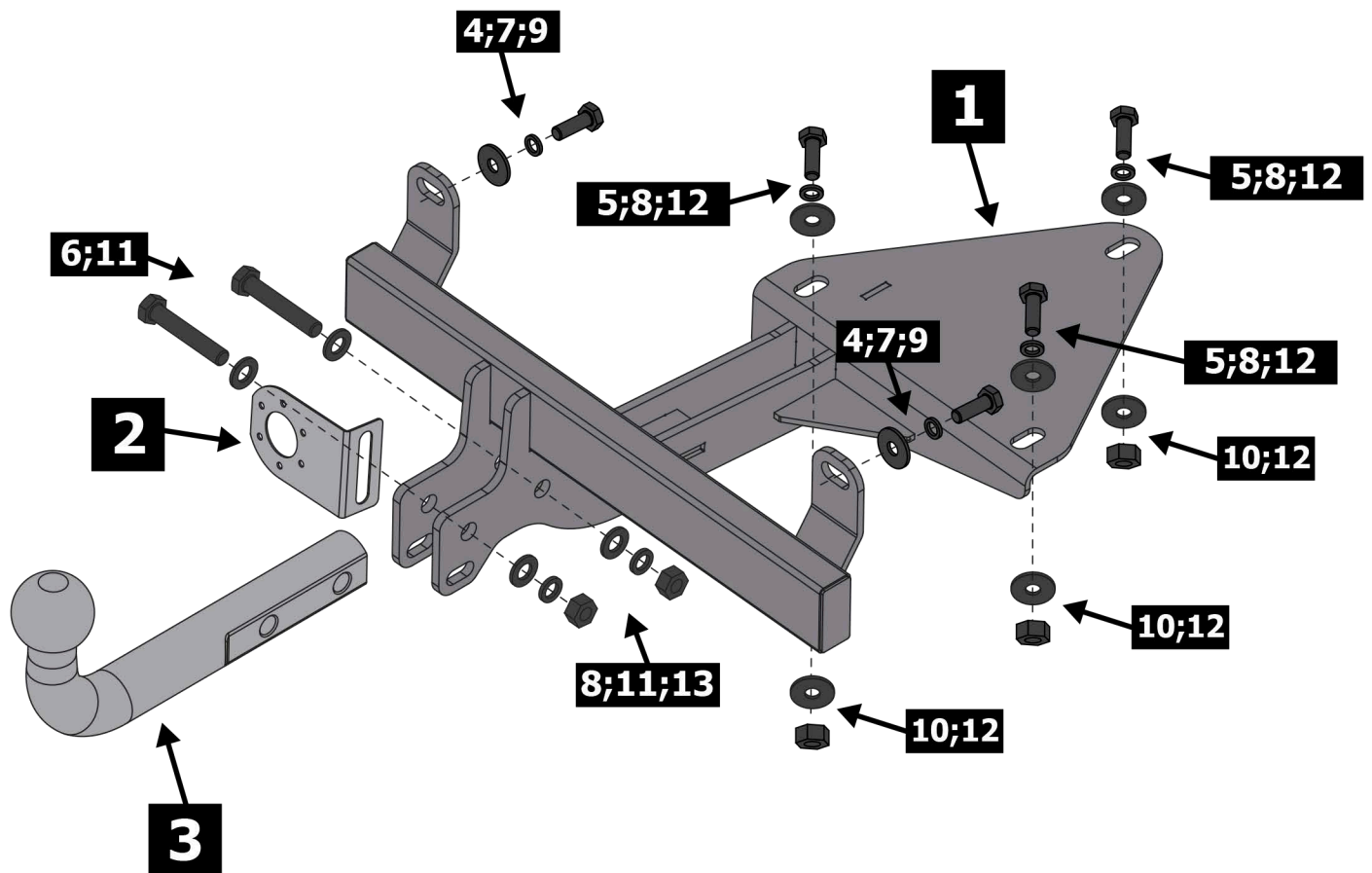
Используемый инструмент:

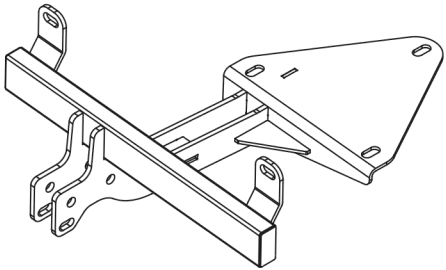
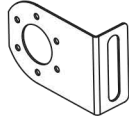
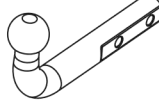
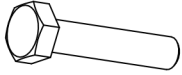
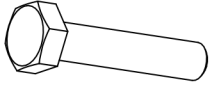
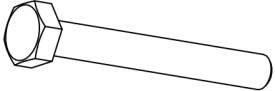

S - 17;
S - 19

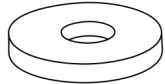

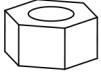
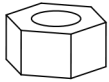
1	x1	Балка	
2	x1	Подрозетник	
3	x1	Крюк	
4	x2	M10x1.25x25	
5	x3	M12x30	
6	x2	M12x1.25x70	
7	x2	∅ 10	
8	x5	∅ 12	
9	x2	∅ 10	
10	x6	∅ 12	
11	x4	∅ 12	
12	x3	M12	
13	x2	M12x1.25	

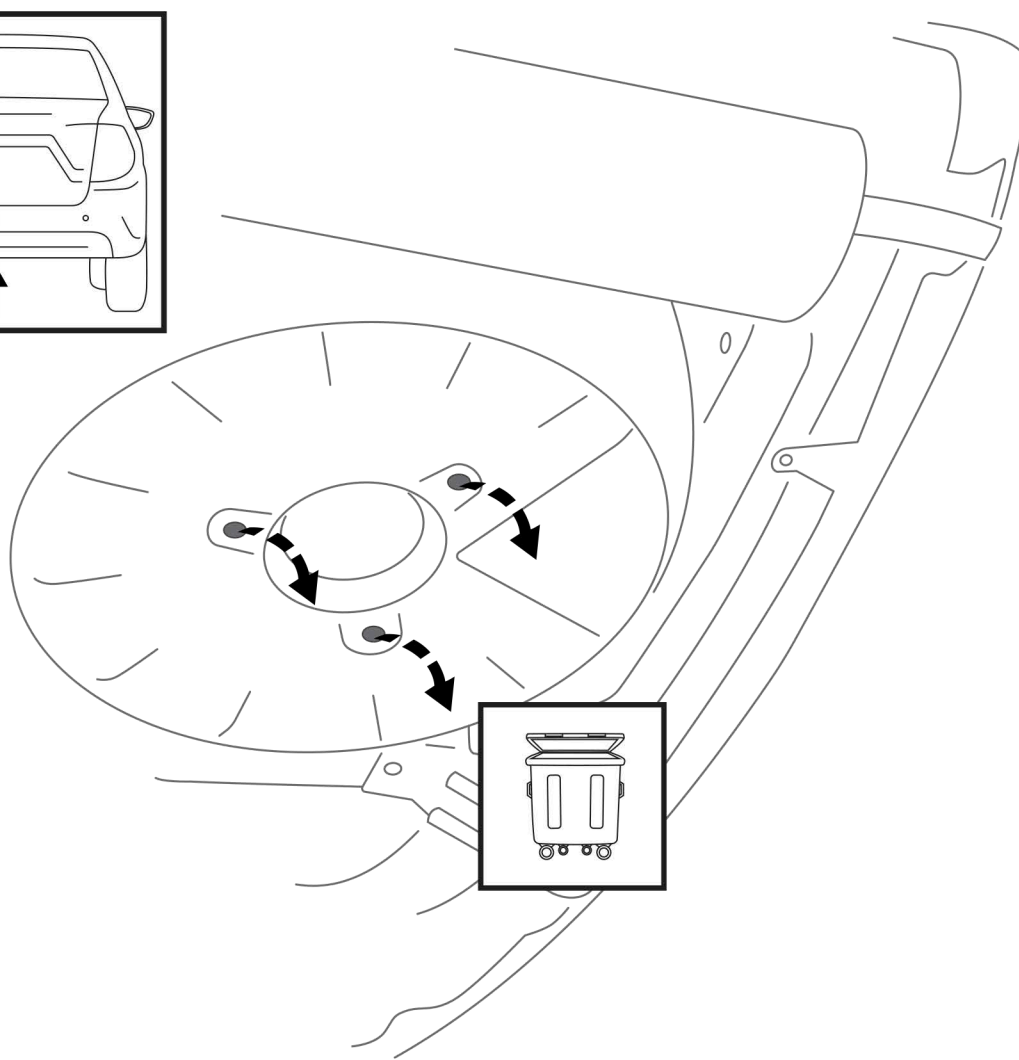
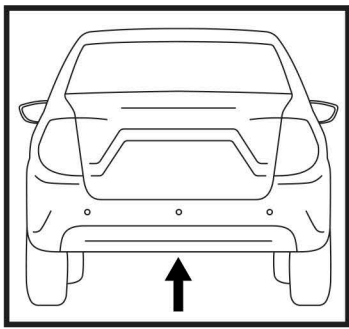

1

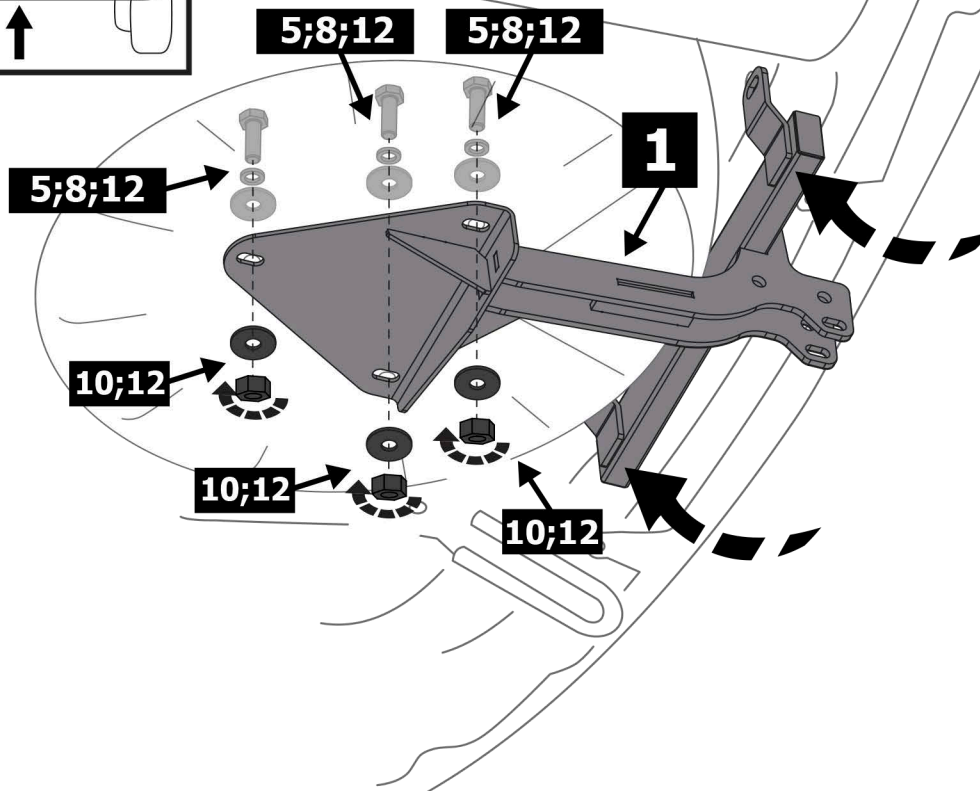
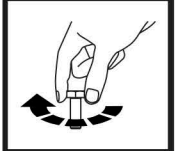
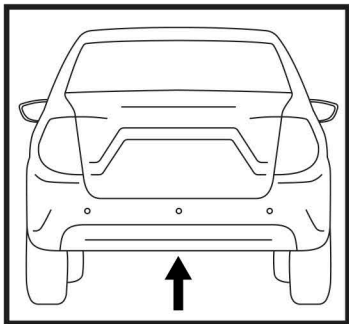

2

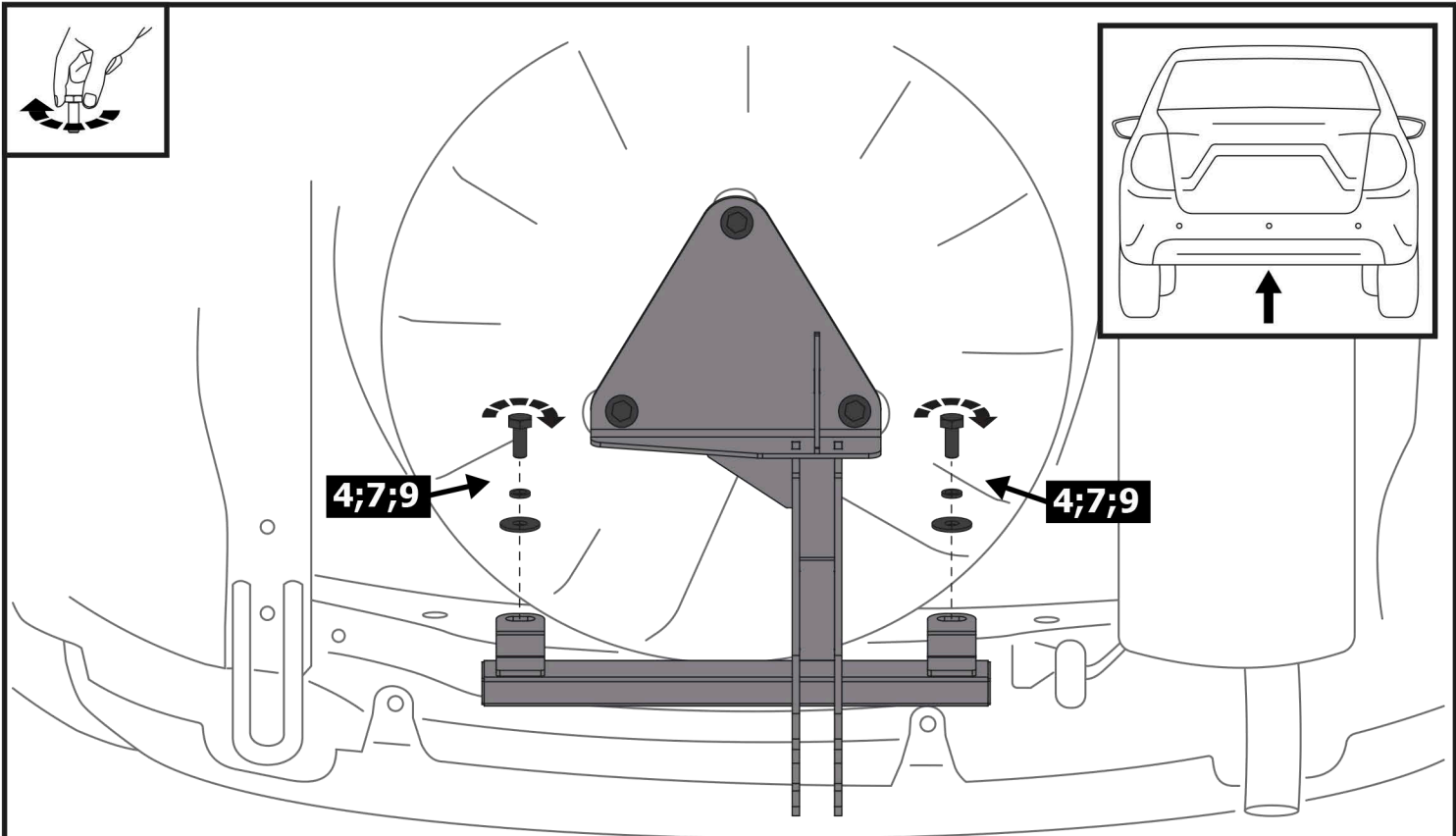

3

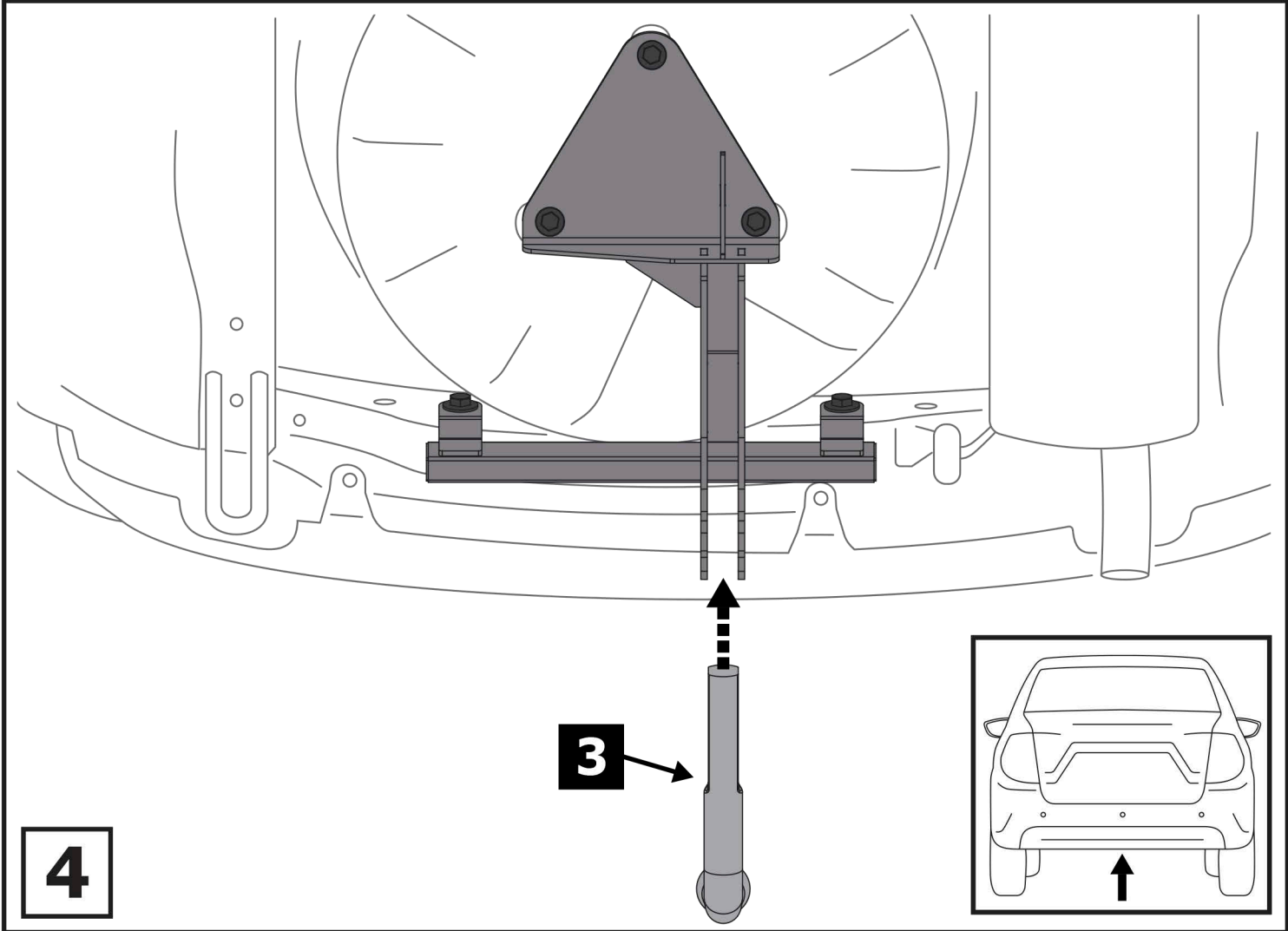

4

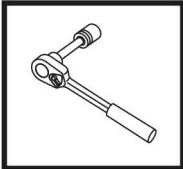
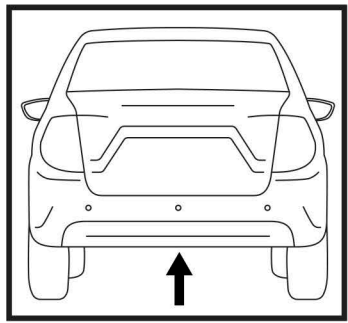
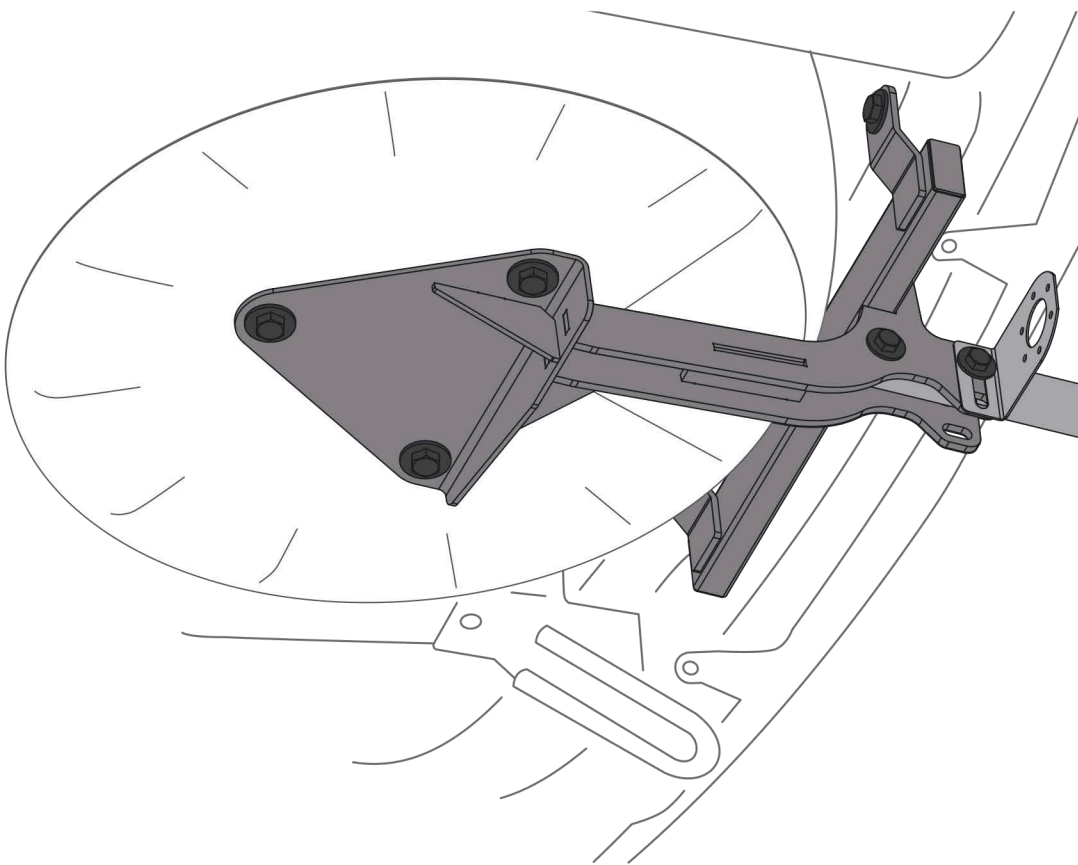
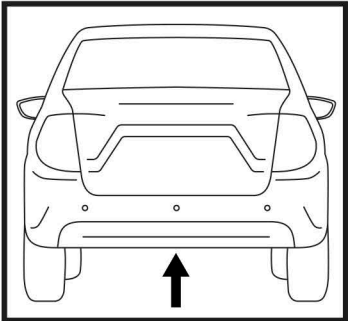
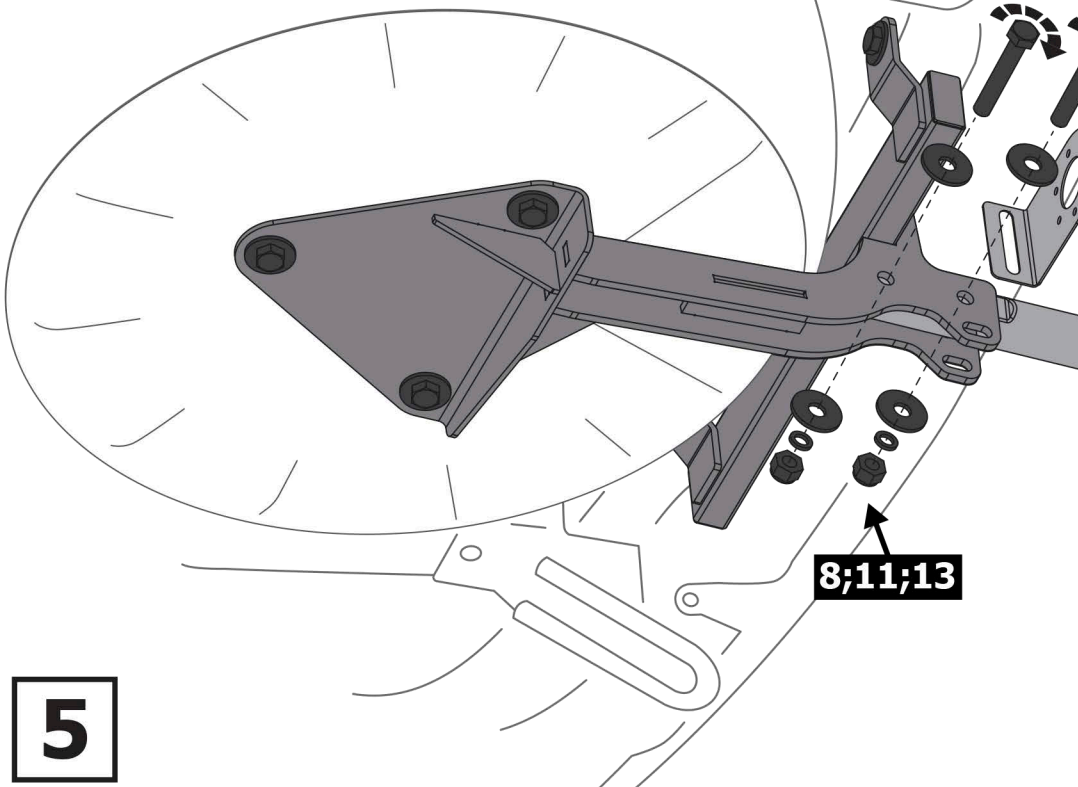

Затянуть все резьбовые соединения
M10 = 47 Nm M12 = 81 Nm

6